

4.1

Montante C-70 Cal 20

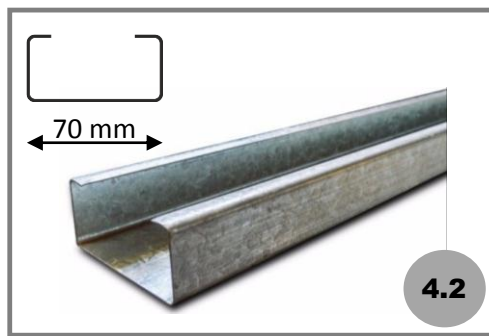

4.2

Montante C-70 Cal 18

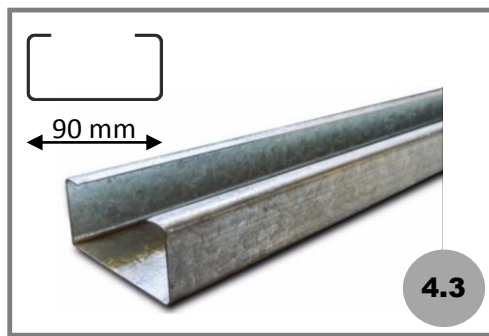

4.3

Montante C-90 Cal 20

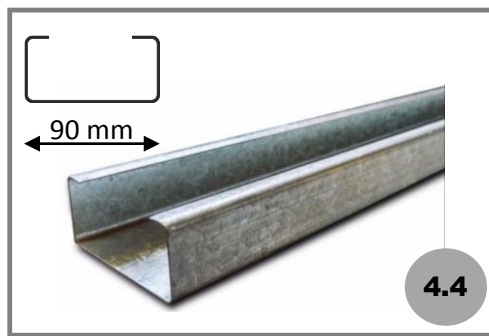

4.4

Montante C-90 Cal 18

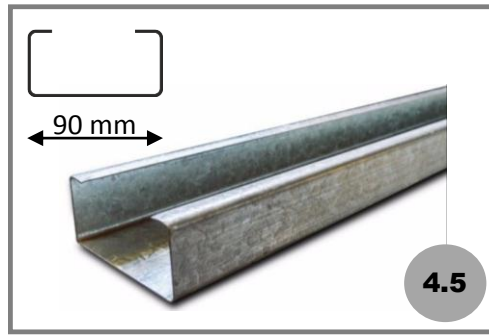

4.5

Montante C-90 Cal 16

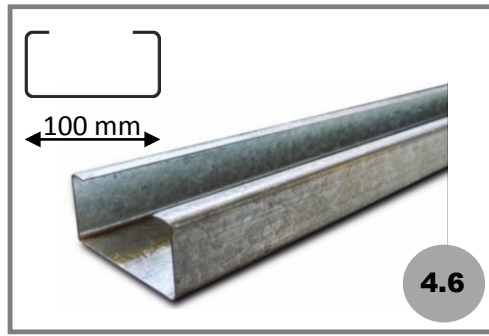

4.6

Montante C-100 Cal 20

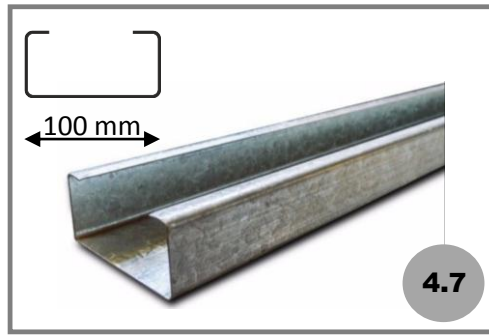

4.7

Montante C-100 Cal 18

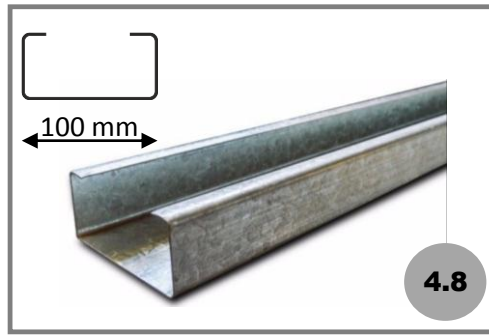

4.8

Montante C-100 Cal 16

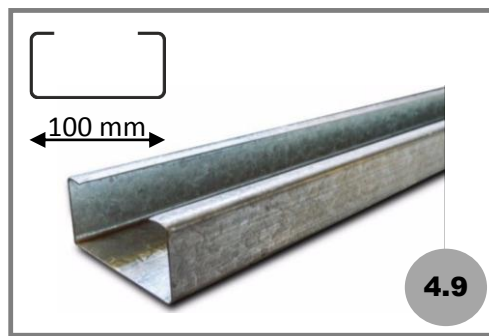

4.9

Montante C-100 Cal 14

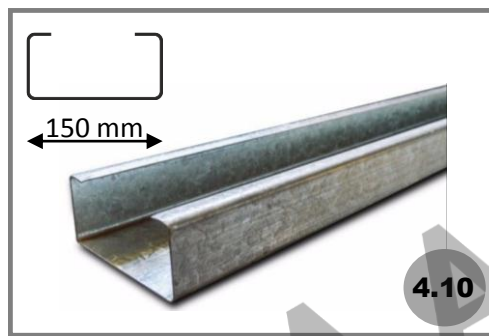

4.10

Montante C-150 Cal 20



4.11

Montante C-150 Cal 18

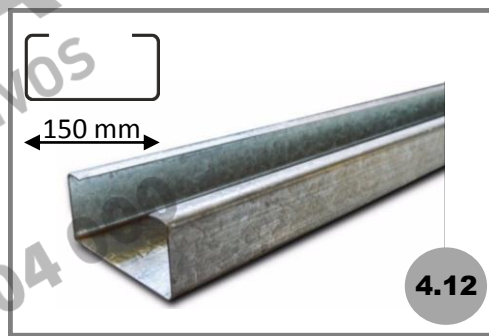

4.12

Montante C-150 Cal 16

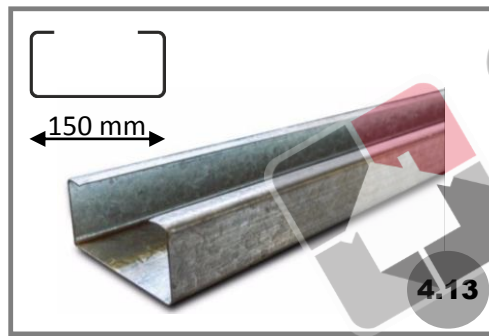

4.13

Montante C-150 Cal 14

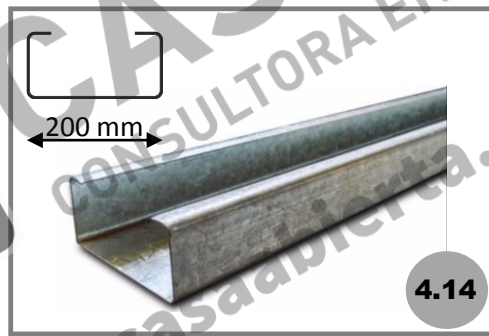

4.14

Montante C-200 Cal 18

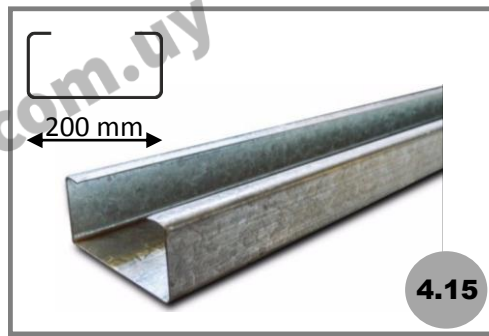

4.15

Montante C-200 Cal 16

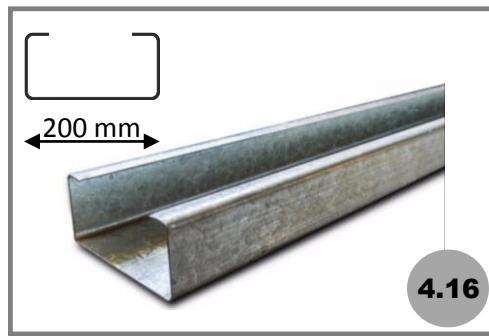

4.16

Montante C-200 Cal 14

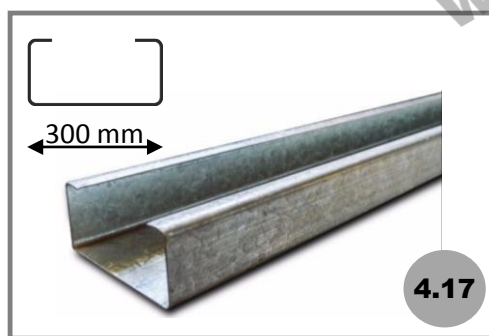

4.17

Montante C-300 Cal 14

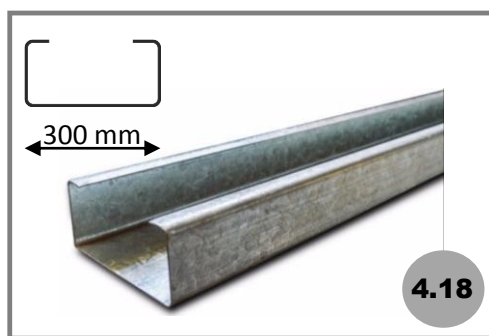

4.18

Montante C-300 Cal 12



4.19

PGO 22 Cal 20



4.20

PGO 22 Cal 18

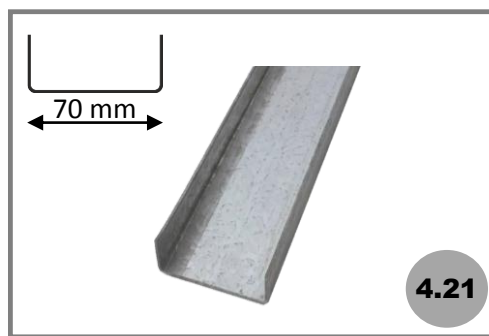

4.21

Solera U-70 Cal 20

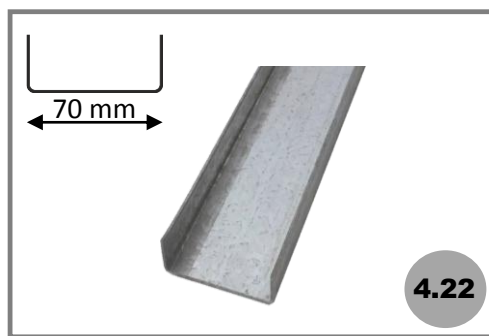

4.22

Solera U-70 Cal 18

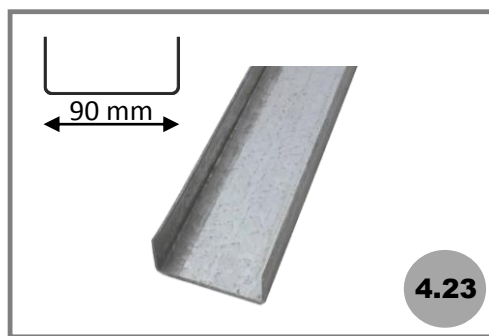

4.23

Solera U-90 Cal 20

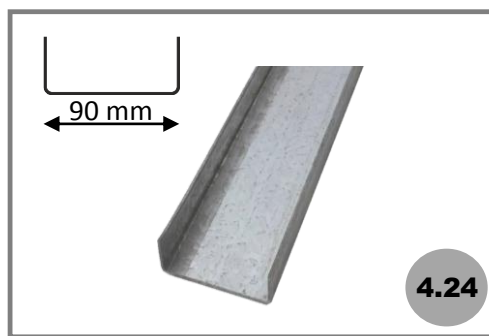

4.24

Solera U-90 Cal 18

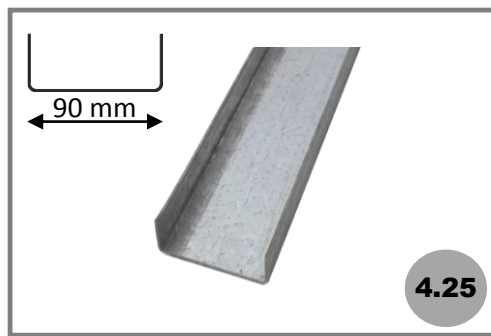

Solera U-90 Cal 16

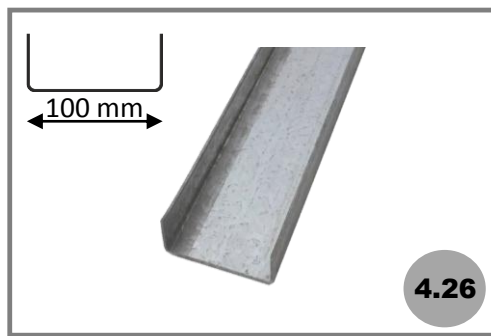

Solera U-100 Cal 20

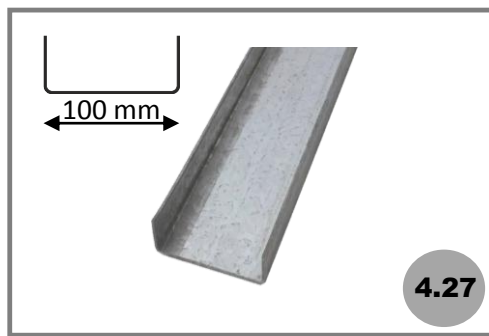

Solera U-100 Cal 18

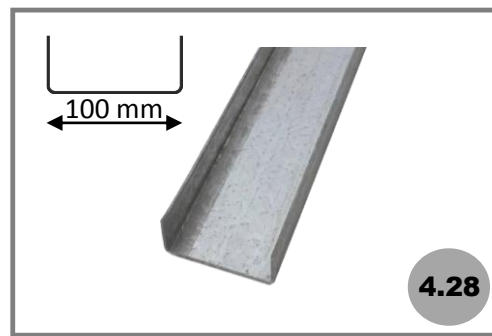

Solera U-100 Cal 16

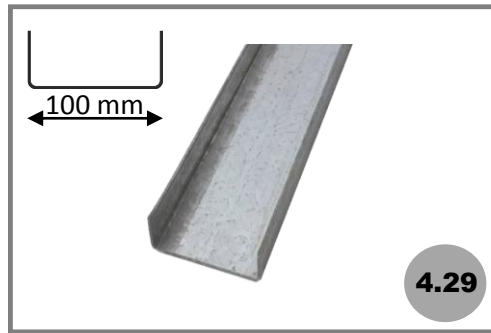

Solera U-100 Cal 14

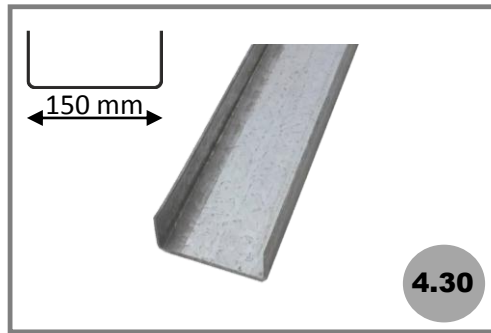

Solera U-150 Cal 20

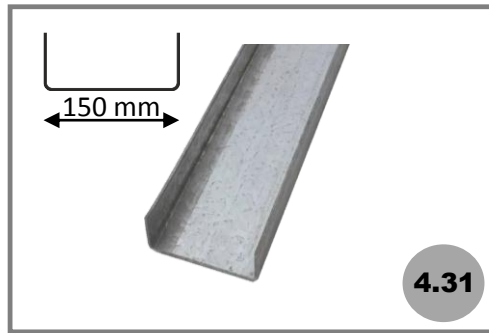

Solera U-150 Cal 18

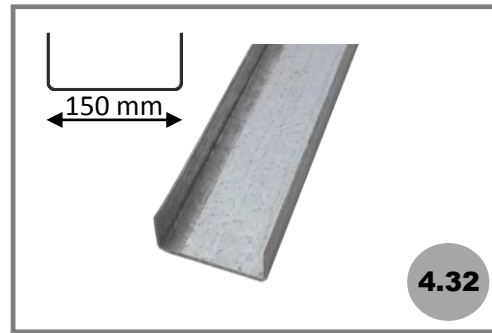

Solera U-150 Cal 16

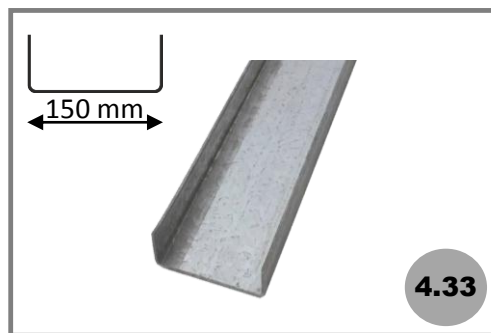

Solera U-150 Cal 14

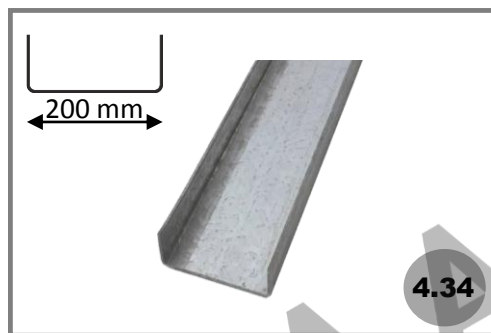

Solera U-200 Cal 18

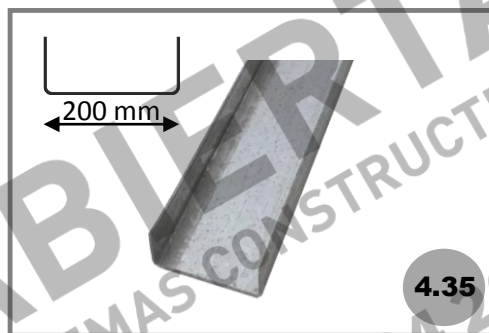

Solera U-200 Cal 16

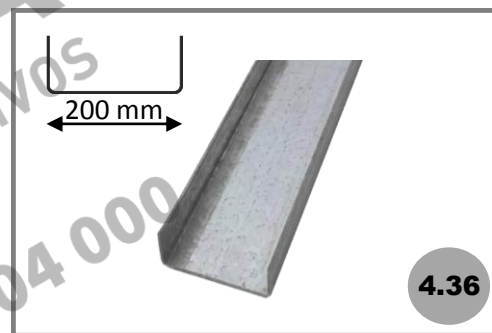

Solera U-200 Cal 14

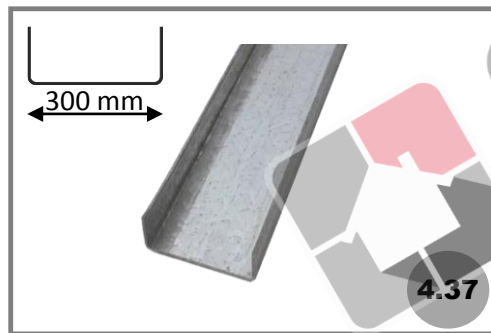

Solera U-300 Cal 14

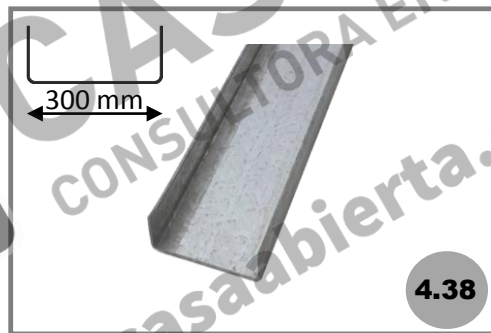

Solera U-300 Cal 12



Fleje - Rollo



HTT4



Ángulo Tensor



Ángulo Conector deslizable

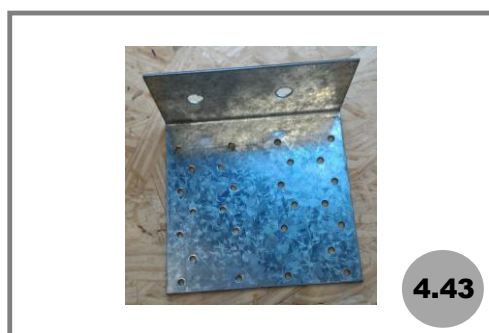

Conector CMV

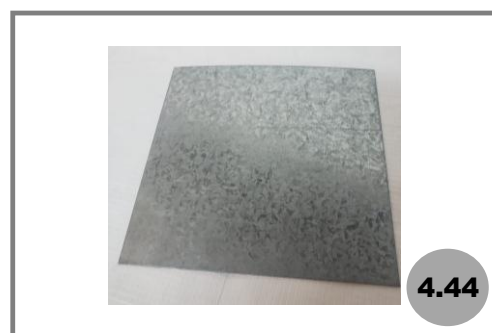

Cartela 15 x 15