

AT-30

6.5

Moldura de Poliestireno

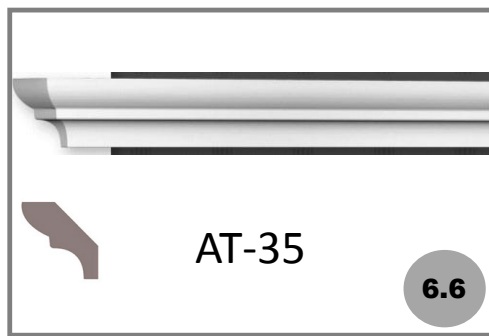

AT-35

6.6

Moldura de Poliestireno

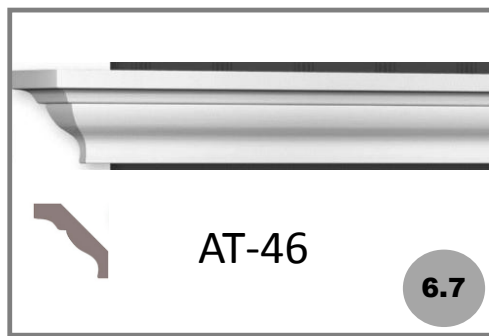

AT-46

6.7

Moldura de Poliestireno

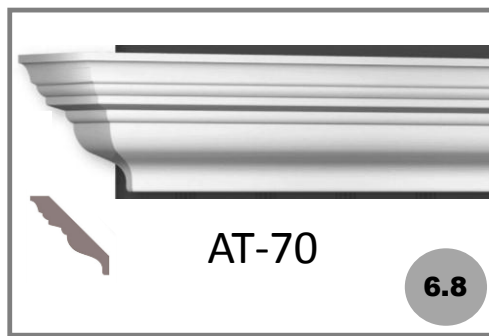

AT-70

6.8

Moldura de Poliestireno

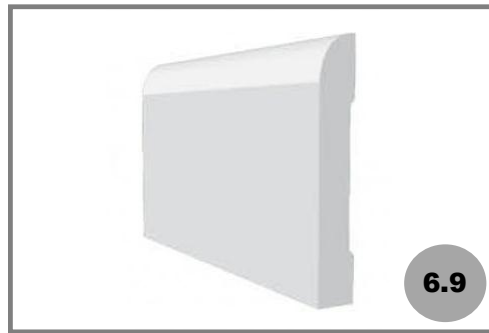

6.9

Zócalo poliuretánico 2.4 m blanco



6.10

Cantonera Metal con papel

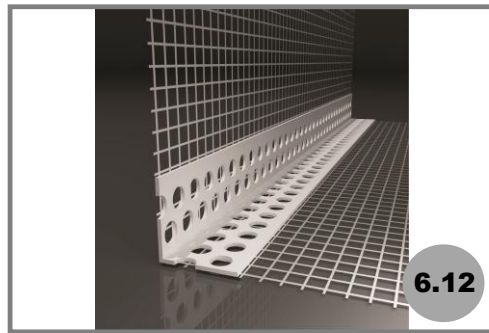

6.12

Cantonera PVC con malla exterior

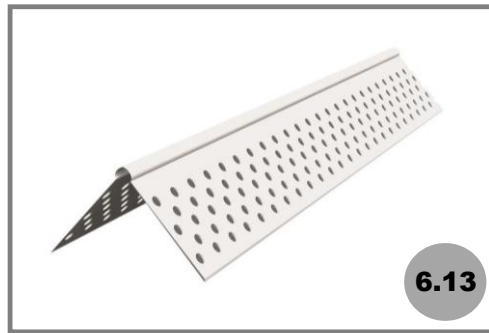

6.13

Cantonera PVC/yeso proyectado

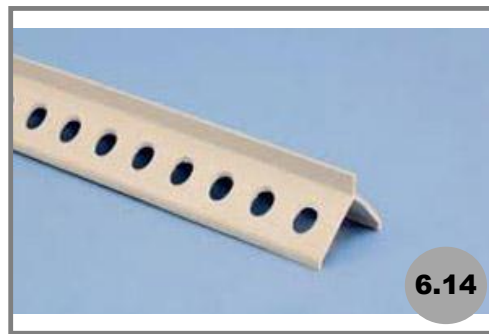

6.14

Cantonera PVC/mortero

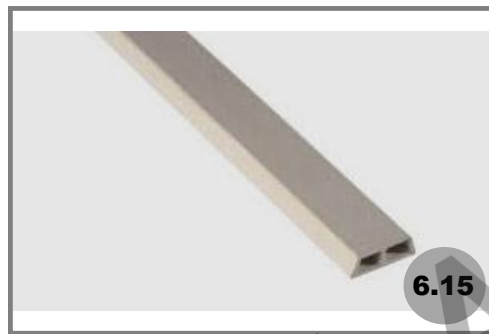

6.15

Junta dilatación (junquillo)

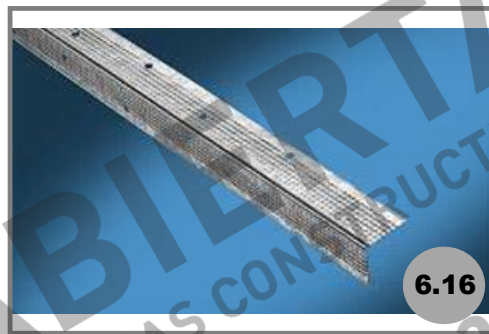

6.16

Cantonera metal



6.17

Ángulo de ajuste L metal con papel

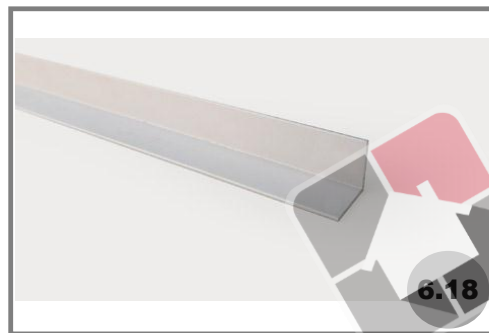

6.18

Angulo de ajuste L PVC



6.19

Perfil ventilación PVC



6.20

Cantonera PVC rígida para exterior

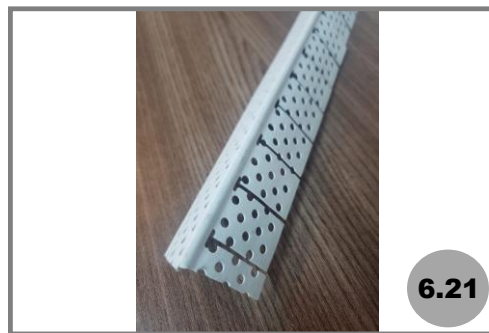

6.21

Cantonera PVC rígida/flexible para interior

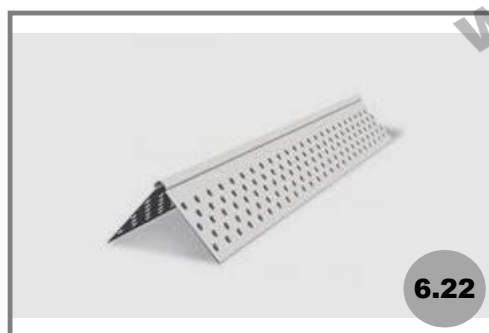

6.22

Cantonera PVC rígida para interior

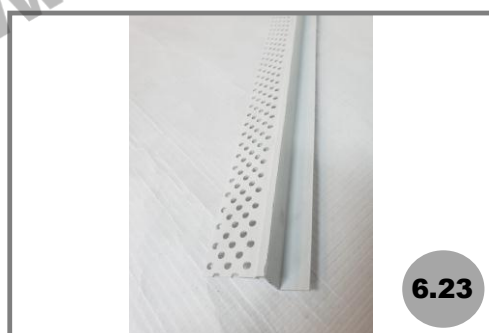

6.23

Perfil buña Z PVC con inserto

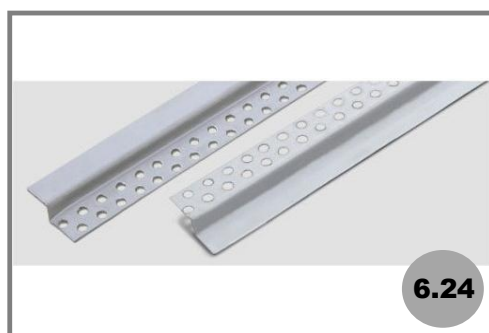

6.24

Perfil buña Z metal pre pintado blanco



6.25

Perfil buña PVC para exterior

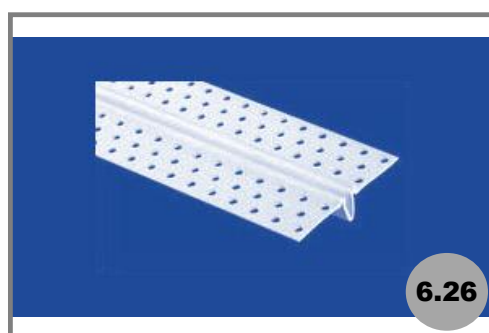

6.26

Pefil Junta Dilatación PVC



6.27

Perfil J PVC 1/2'' para exterior

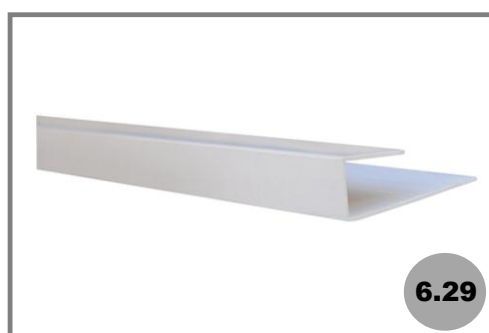

6.29

Perfil J revestimiento

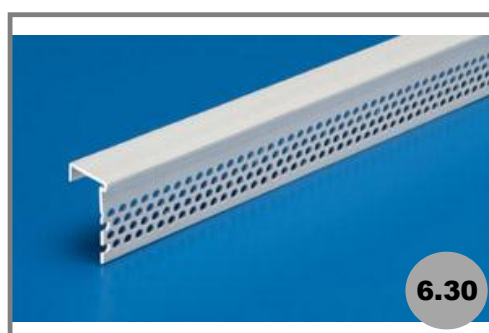

6.30

Perfil J PVC 1/2'' para interior

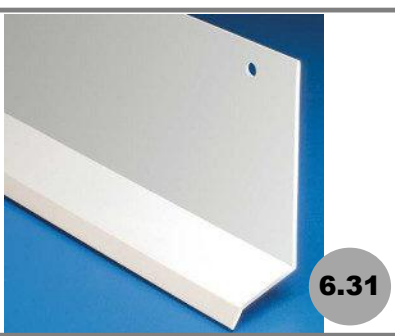

6.31

Perfil Drip flashing PVC 2"

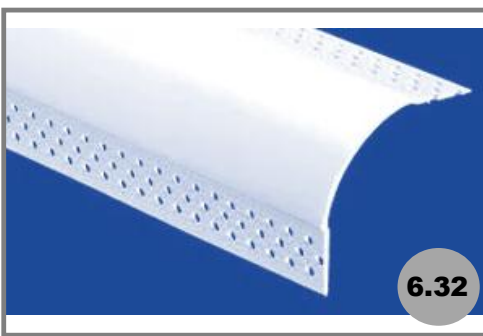

6.32

Cantonera Sanitaria exterior PVC

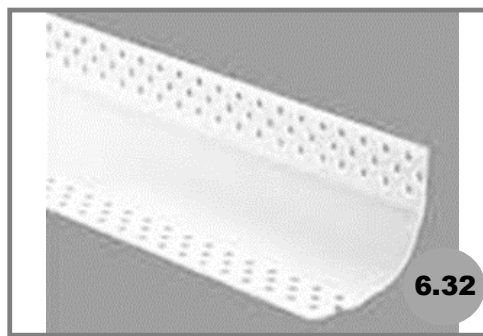

6.32

Cantonera Sanitaria interior PVC



6.33

Panel de acceso Durlock marco oculto



6.34

Panel de acceso PVC 4x6", 6x9", 8x8", 12x12"



6.41

Sellador acústico



6.42

Sellador acústico e ignifugo Metacaulk



6.43

Sikaflex AT connection



6.44

Sikaflex A1



6.45

Silicona neutra



6.46

Poliuretano expandido P-45



6.47

Adhesivo montaje clavo líquido Forte



6.48

Anclaje químico Sika



6.49

Comprimanda 35 mm x 6 m



6.50

Comprimanda 70 mm



6.51

Rejilla de piso, móvil



6.52

Panel de ventilación cielorraso



6.53

Rejilla de ventilación móvil - Pared